

FCI:240PC02S1001
FCI:60010434
接液罐控制阀 EN05

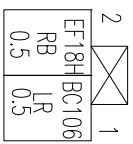

KEI:MG641152-4
或HL:DLR02FGY
喷油嘴4 EN23

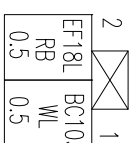

KEI:MG641152-4
或HL:DLR02FGY
喷油嘴3 EN22

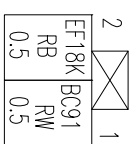

KEI:MG641152-4
或HL:DLR02FGY
喷油嘴2 EN21

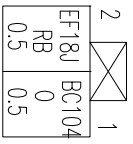

KEI:MG641152-4
或HL:DLR02FGY
喷油嘴1 EN20

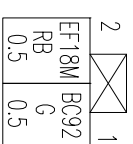

FCI:211PC062S1149
TE:1670328-1
接点火线圈 EN15

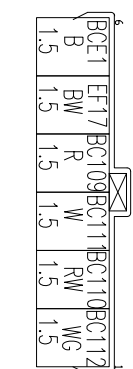

接套:211PC022S6149
接PVC阀 EN09

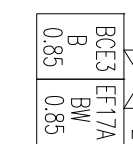

接套:1-1801175-5
FCI:211CC2S1460P
接水温传感器 EN12

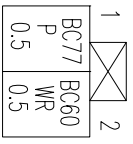

接爆震传感器 EN13
FCI:211PC022S0149
DEL:15414437

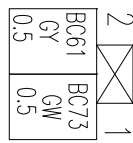

FCI:211PC022S0149
FCI:211CC2S1160P
接发电机控制 EN17

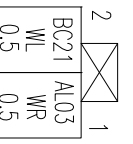

TE:1-1801175-3
FCI:211CC2S1160P
接机油压力传感器 EN14

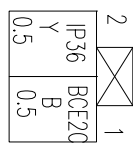

FCI:211PC042S8021
TE:1564724-1
接进气温度压力传感器 EN16

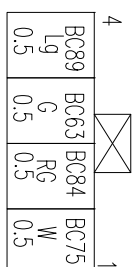

FCI:211PC062S1149
TE:1564724-1
TE:1670326-1
接电子节气门体 EN25

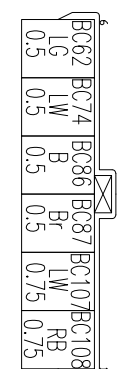

TE:1-1801178-3
FCI:211CC2S1460P
接凸轮轴相位传感器 EN11

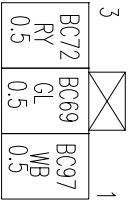

KUM:PB625-02027
KUM:PB875-02900(卡子)
接倒档开关 EN08

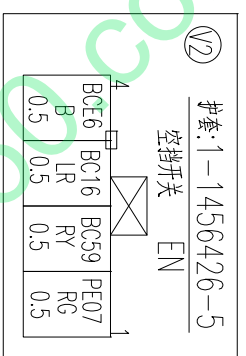
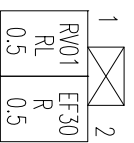

TE:1-1801175-1
DEL:15414437
接发动机转速传感器 EN10

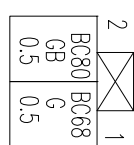

AMP:144998-3(蓝)
AMP:144998-6(绿)
接后氧传感器 EN03



AMP:144998-6(绿)
接前氧传感器 EN04

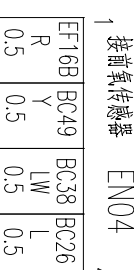

TE:1-1801175-1
TE:1564724-1
可变凸轮正时阀 EN07

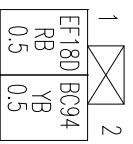

FCI:211PC022S4149
压缩机电磁离合器 EN18

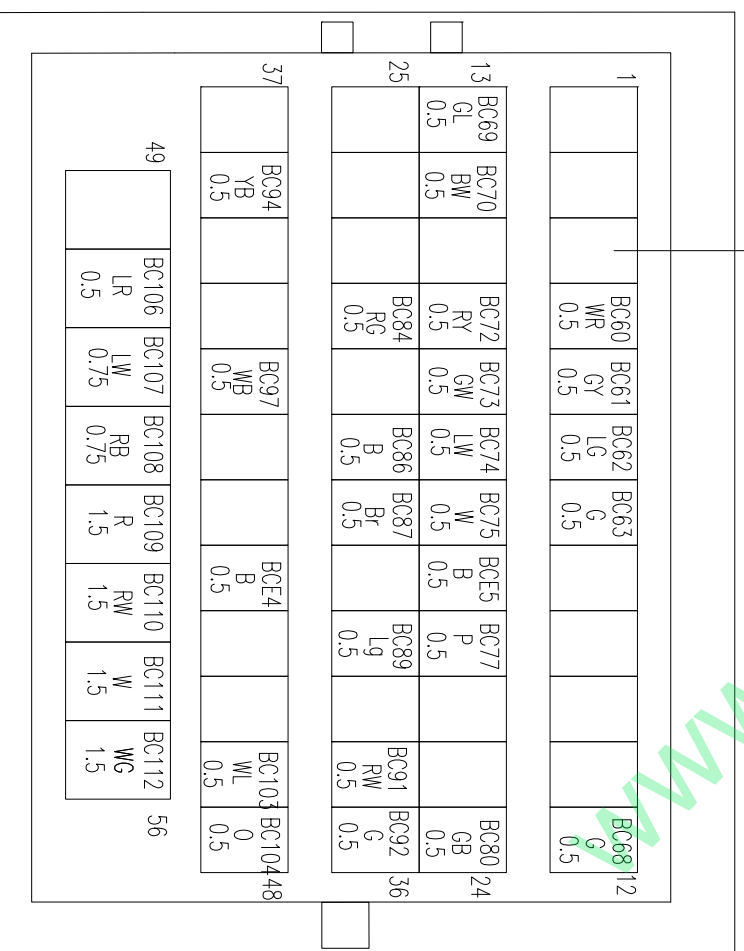
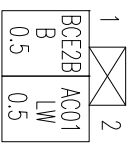

BOSH:1928 405 161(主体)
BOSH:1928 405 164(上盖)
发动机 ECU CODE13 EN01

TE:936421-2
后护套:936615-2
接机舱电线束总成 EN-FB1

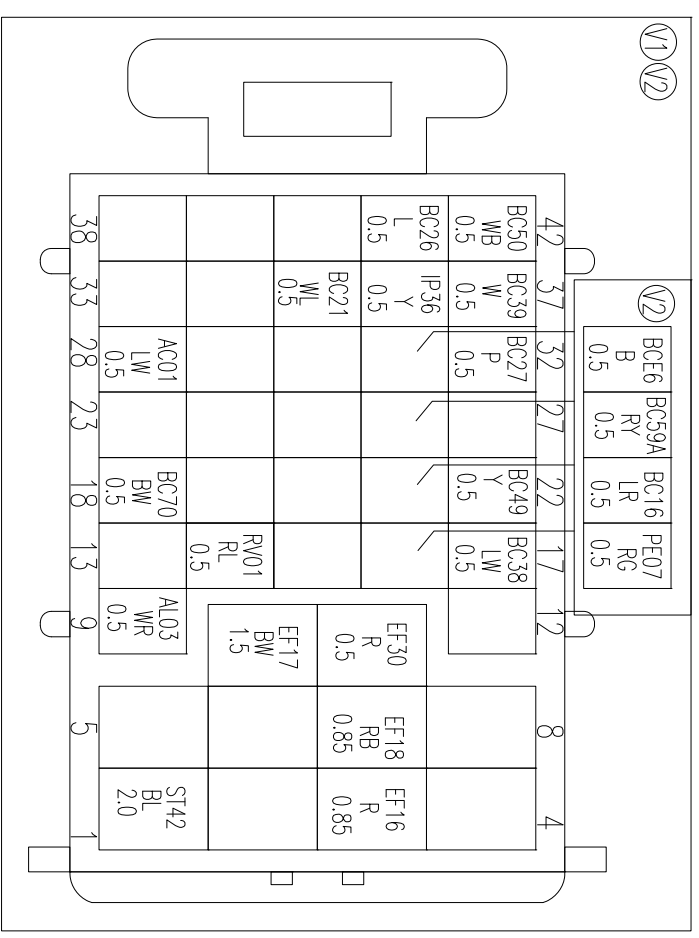

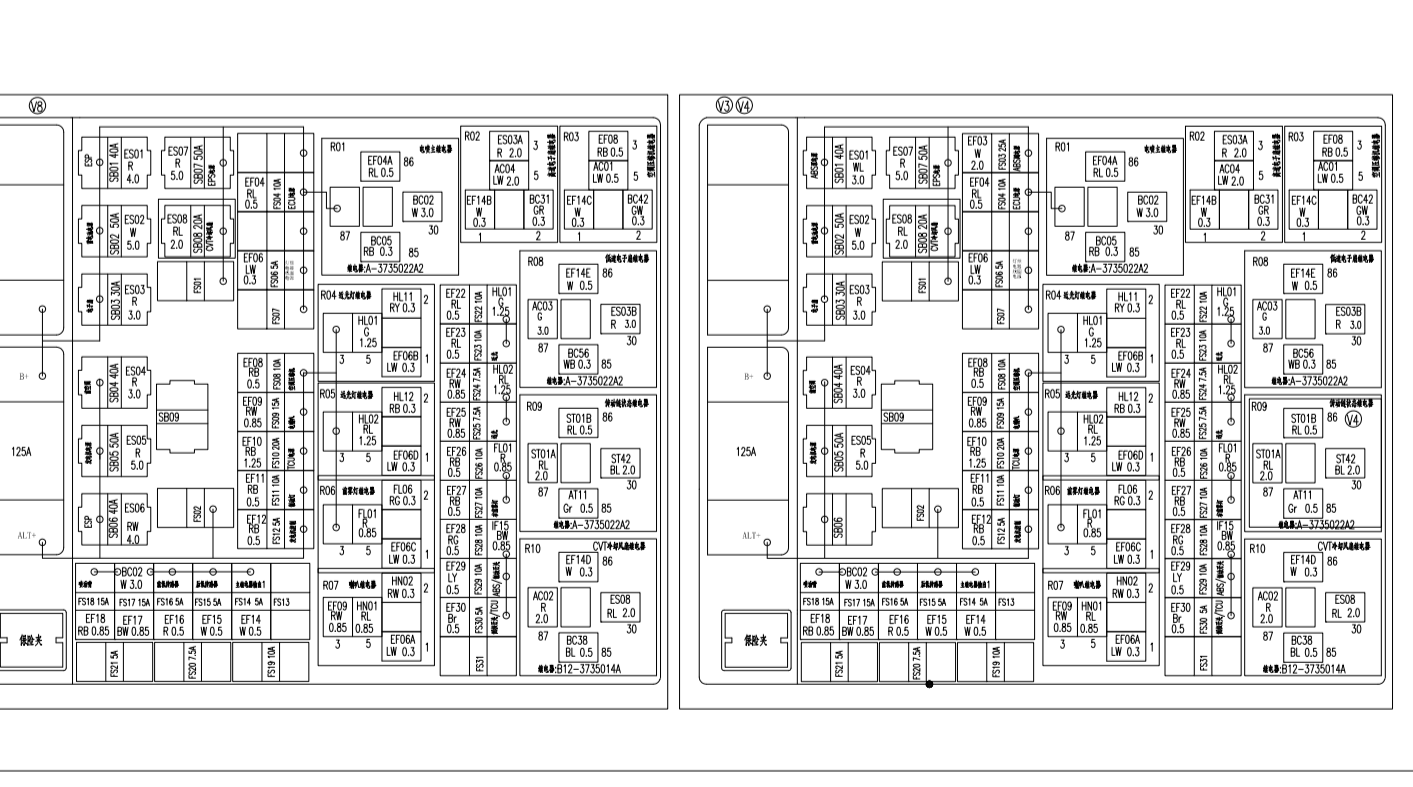
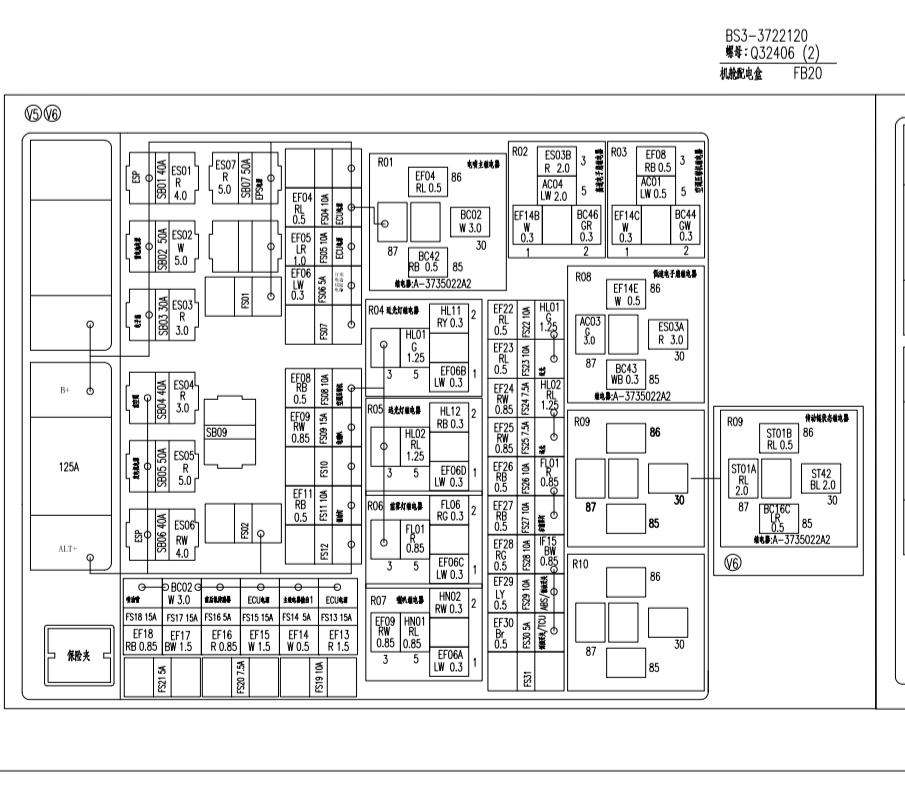
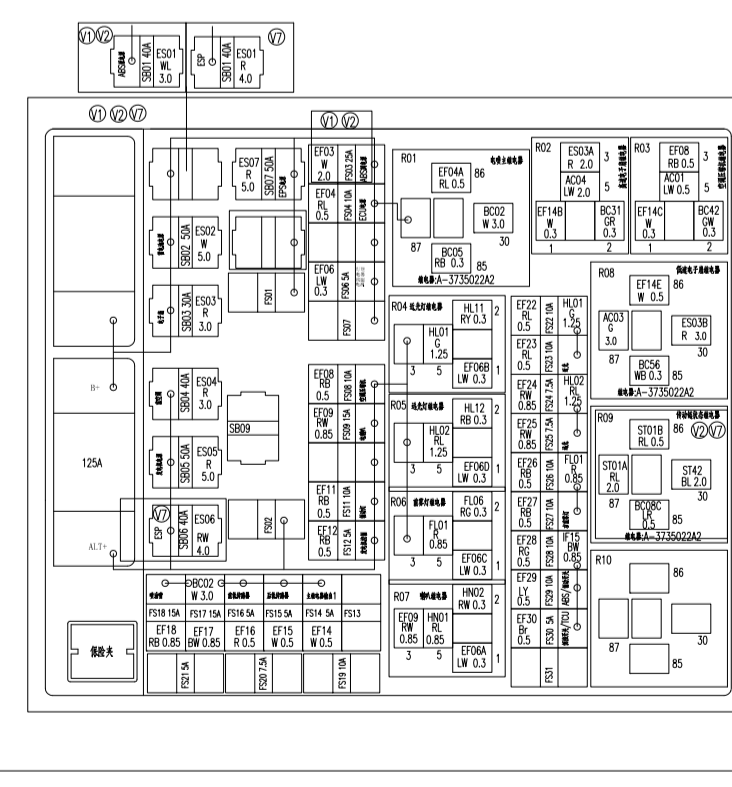
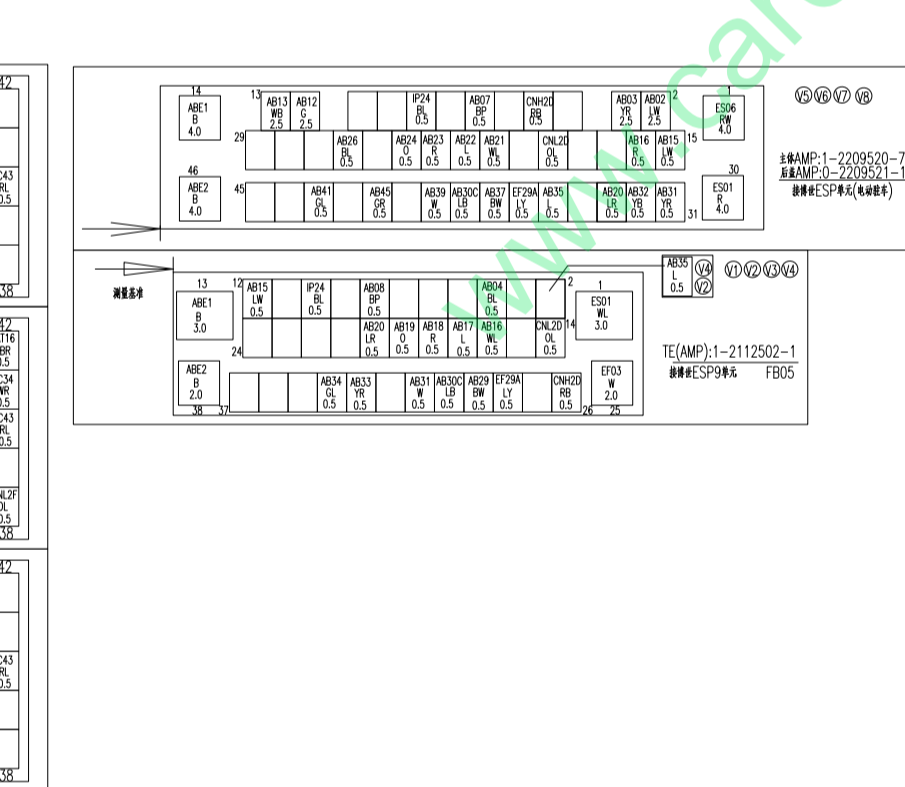
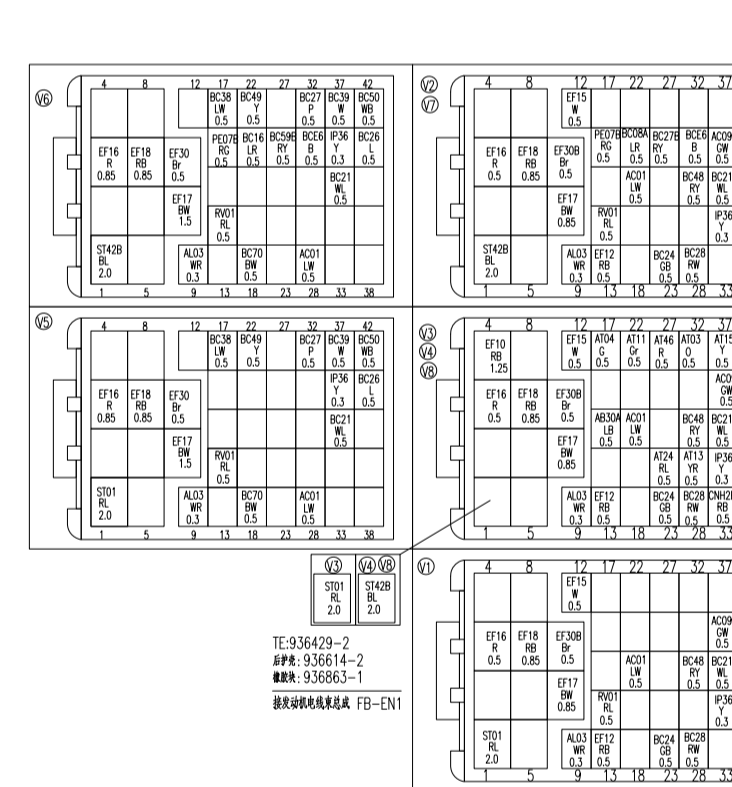
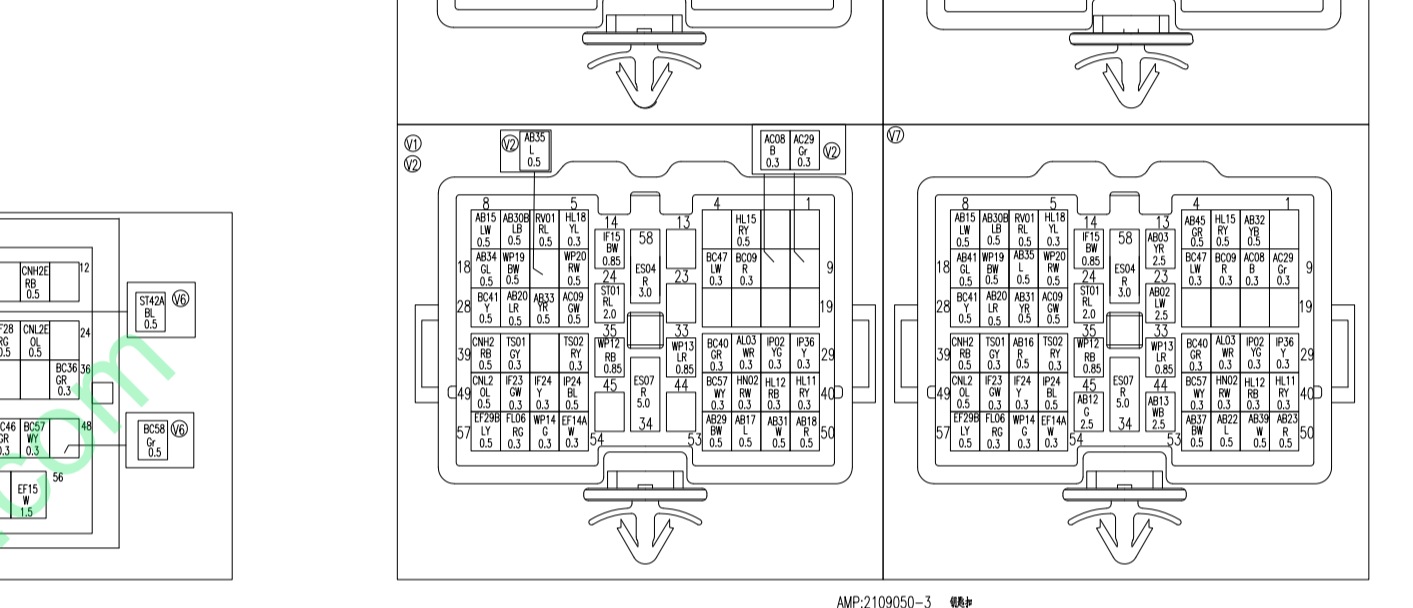
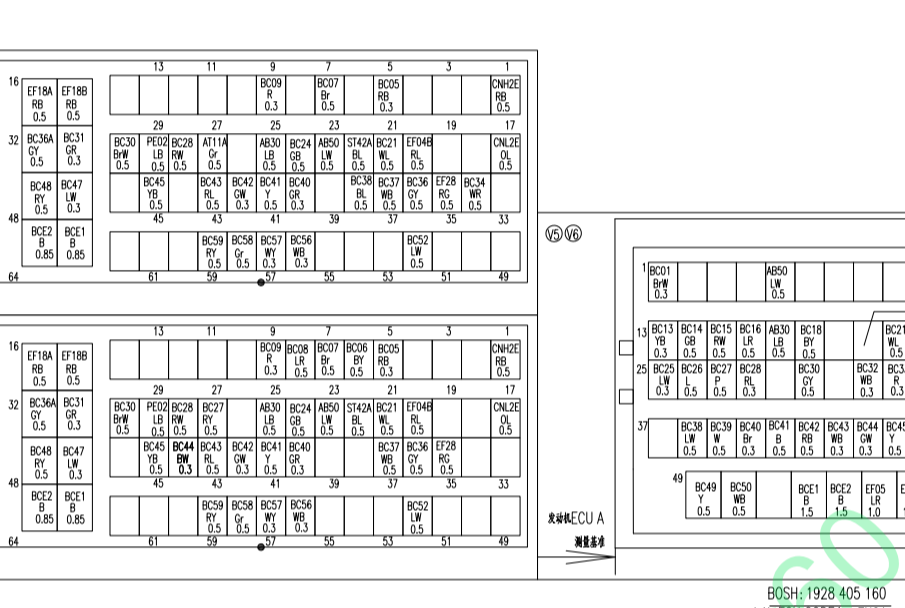
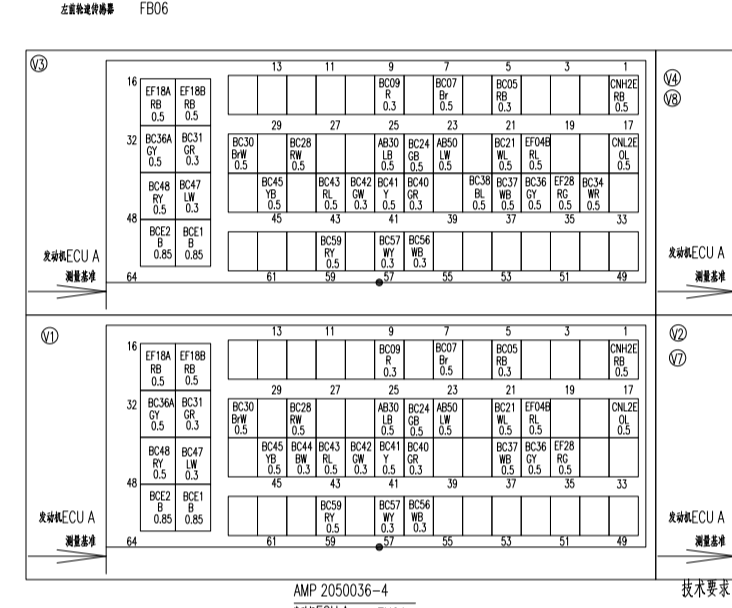
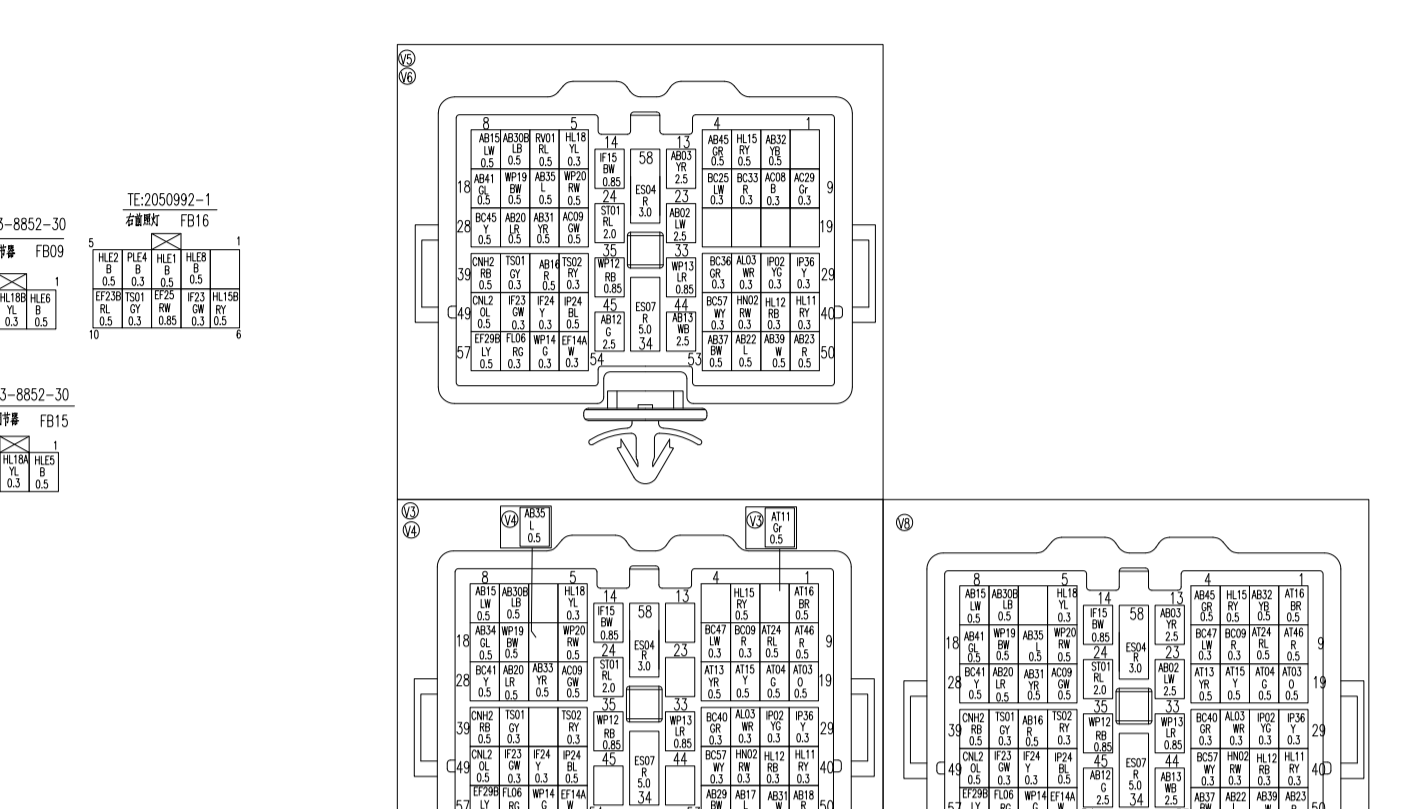
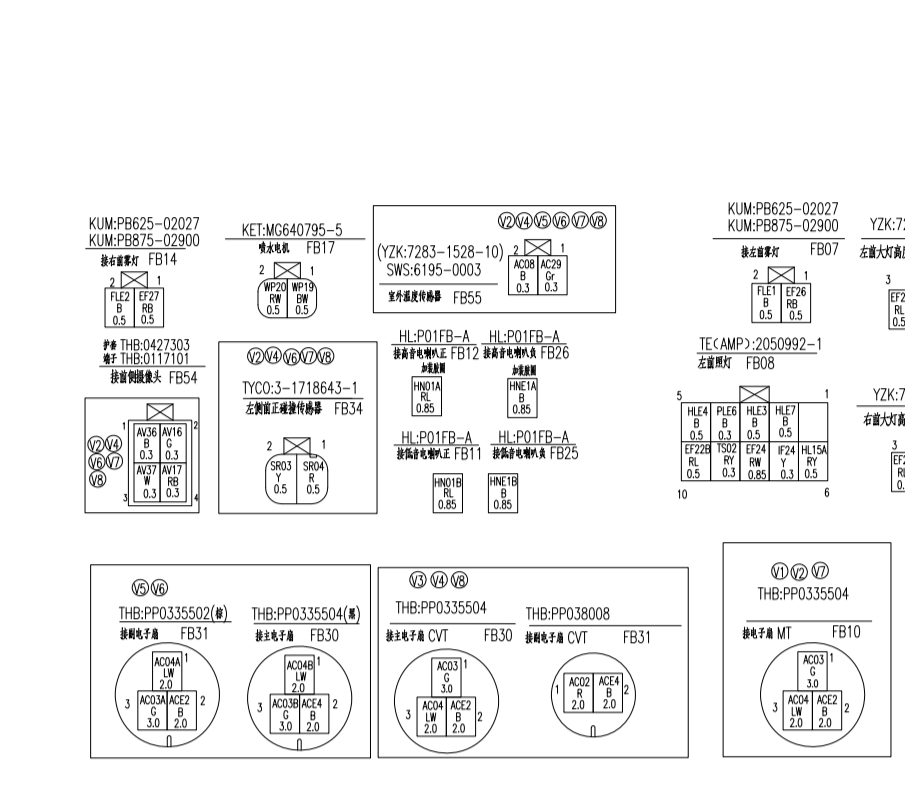
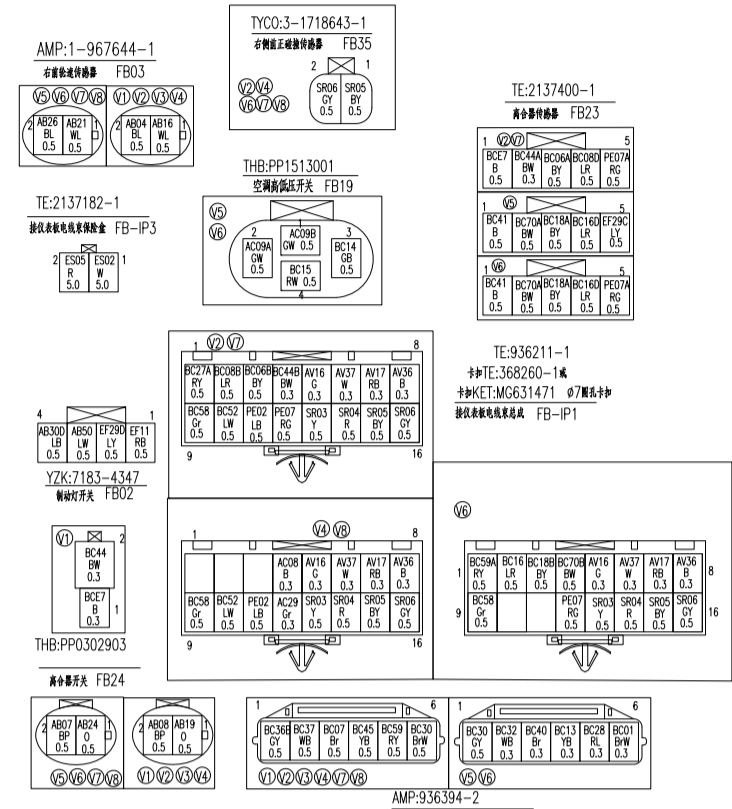

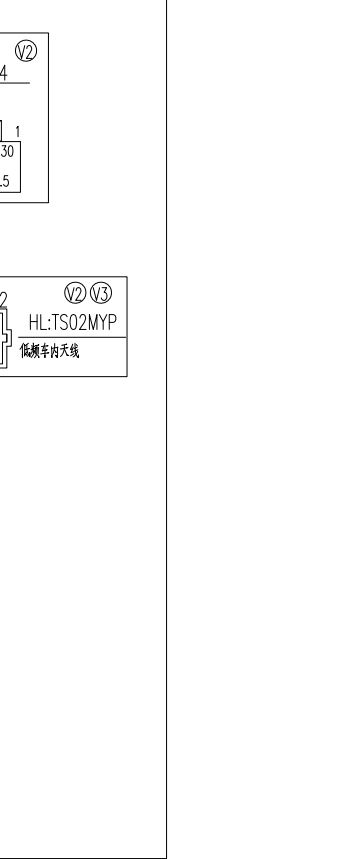
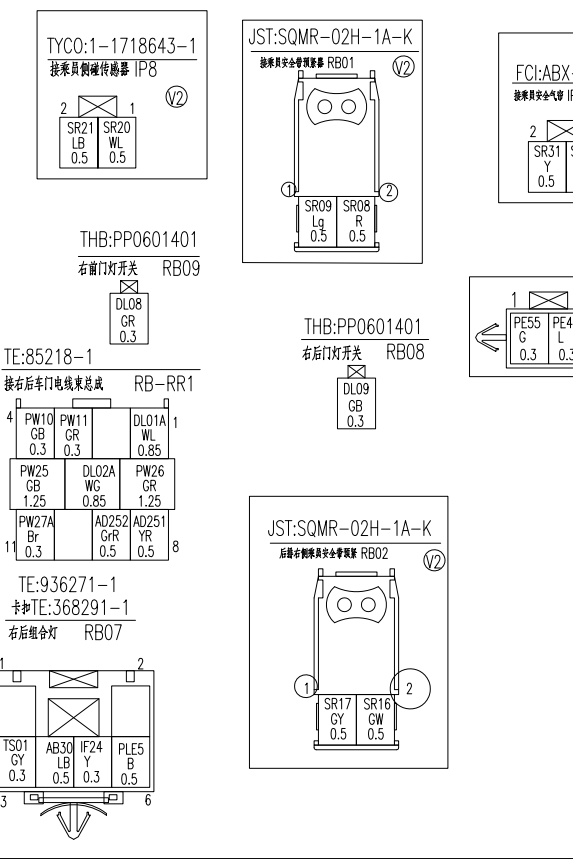
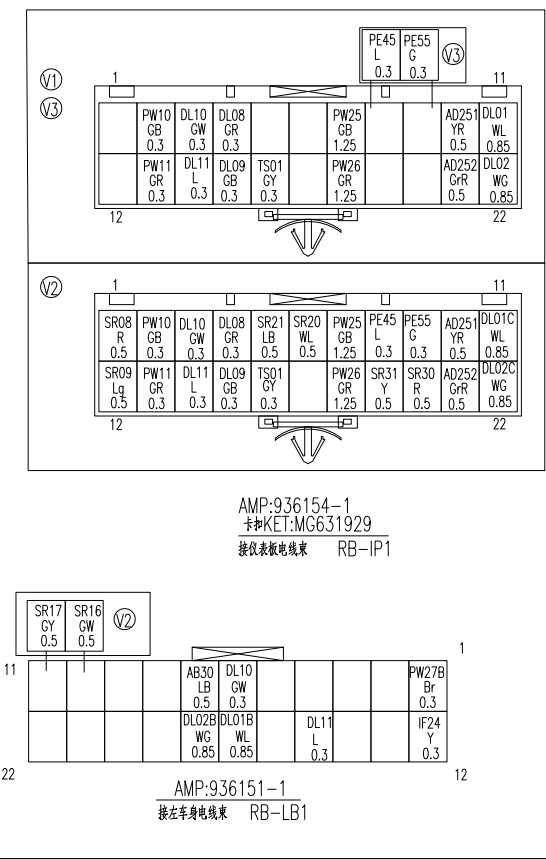
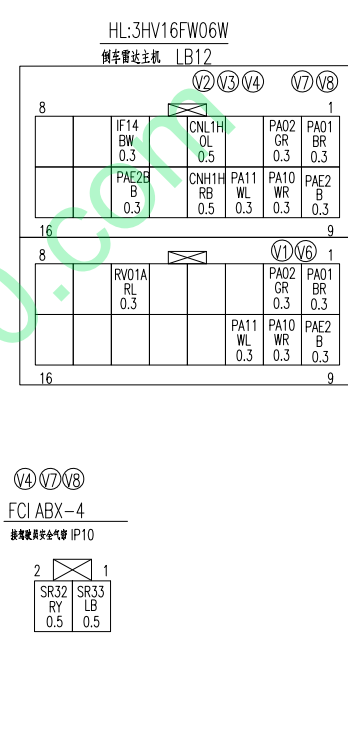
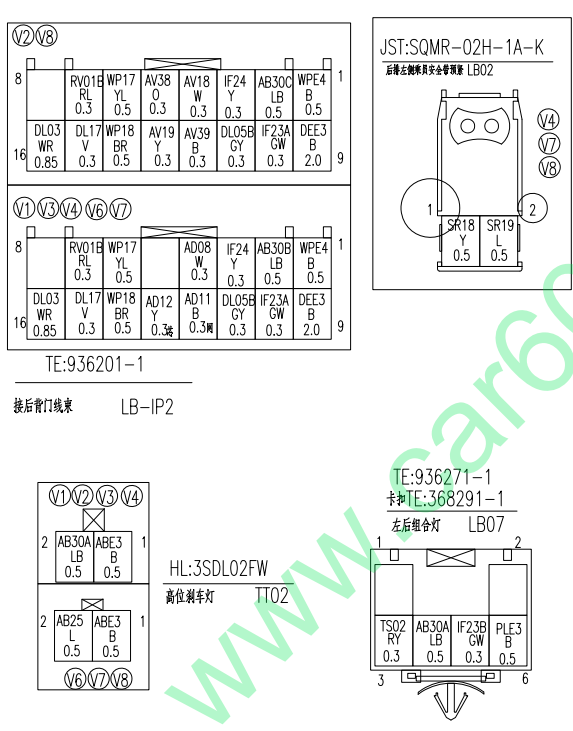
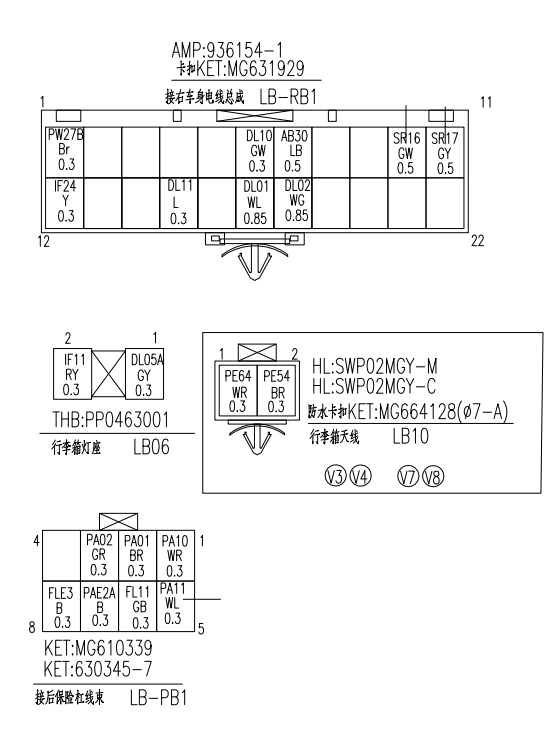
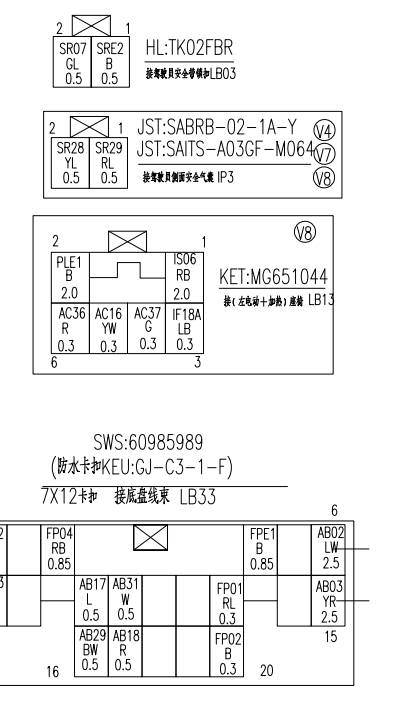
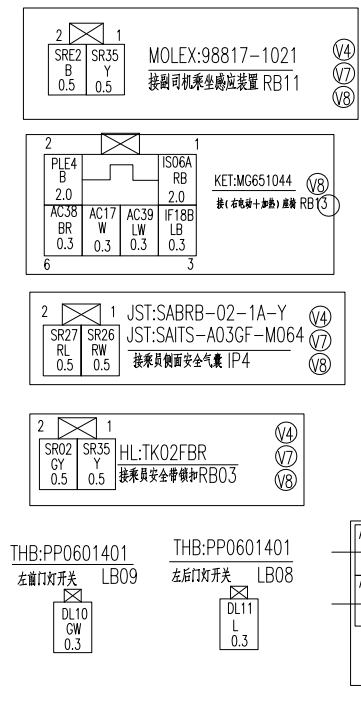
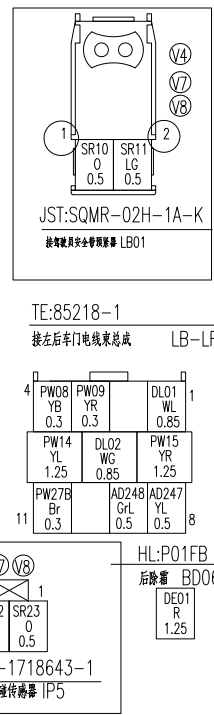
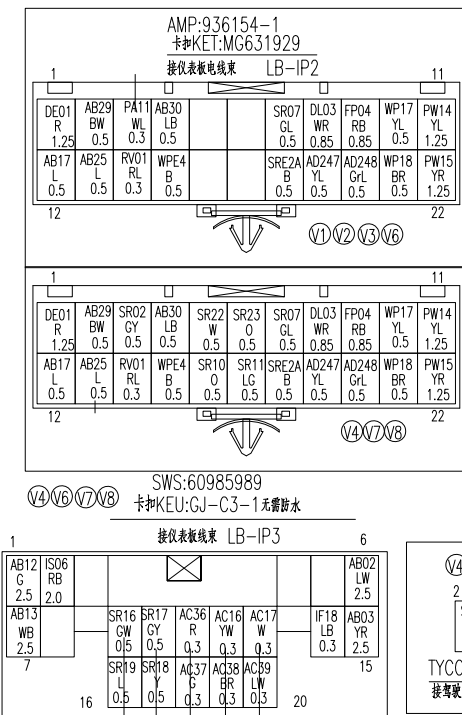
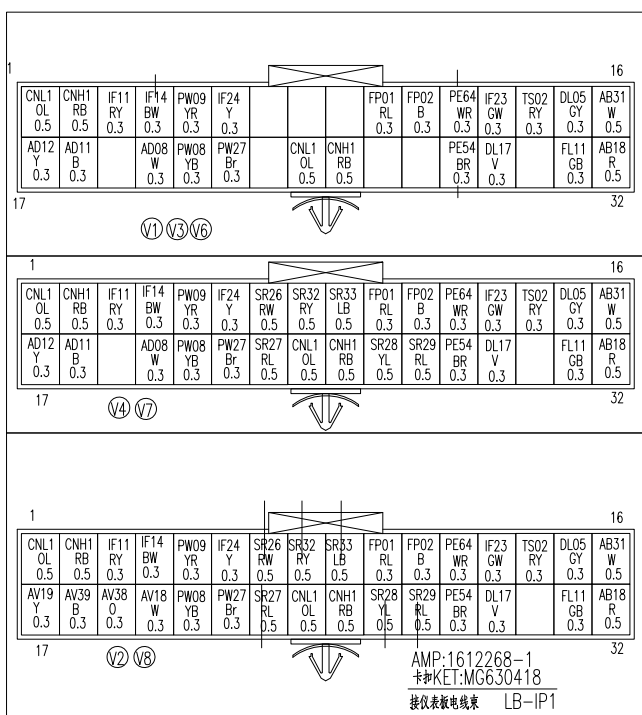

KET:MG621807
KET:MG631808-3(2件)
接收表板线束 LD-IP1

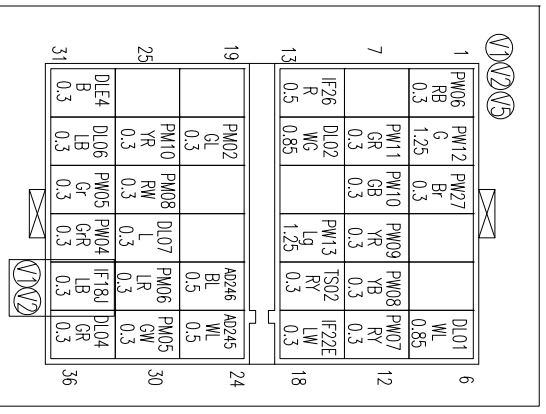

YZK:7283-8853-30
接车门天线线束开关 LD03
接收表板线束

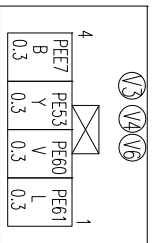

#泰: HL:3TK12MW
卡扣: KET:MG630418
接左后座线束 LD01

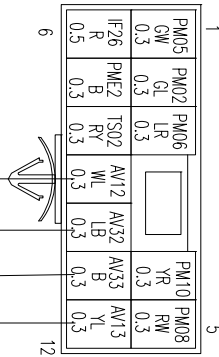

KET:MG651110
接左前门玻璃升降开关 LD05

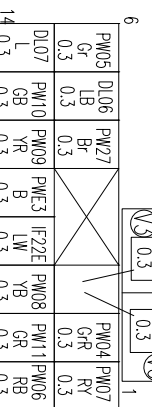

HL:NTL06BSL
接左前门线束 LD06

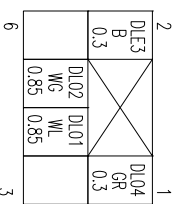

KET:MG621807
KET:MG631808-3(2件)
接收表板线束

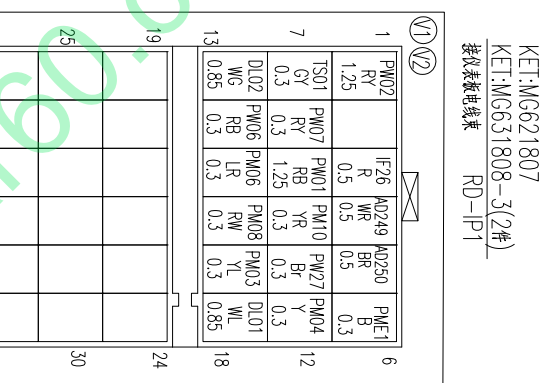

YZK:7283-8853-30
接车门天线线束开关 RD03

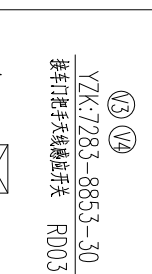

#泰: HL:3TK12MW
卡扣: KET:MG630418
接右后座线束 RD01

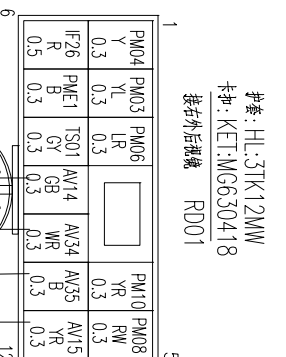

SWS:6189-0133
右前玻璃升降电机 LD03

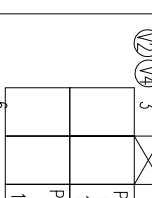

TY00:85216-1
接车身线束总成 LR-LB1

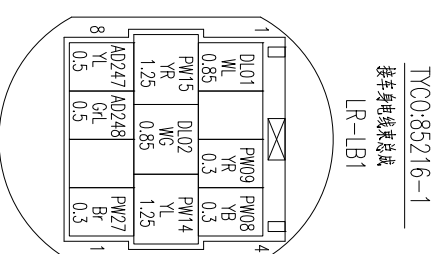

FCI:211PC022S8049
后门玻璃升降电机 RR04

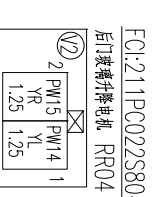

HL:NTL06BSL
接后车门线束 LR06

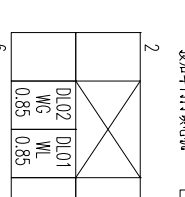

SWS:6189-0133
后门玻璃升降电机 RR04

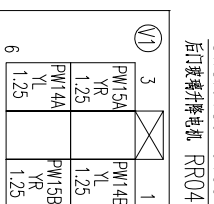

TE:1355390-1
接后门线束 LR01

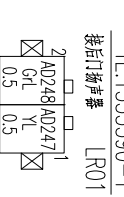

FCI:211PC022S8049
左前玻璃升降电机 LD03

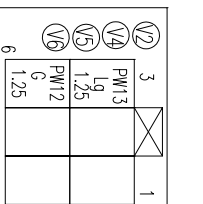

SWS:6189-0133
左前玻璃升降电机 LD03

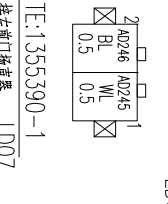

TE:9382939-2
接左前车身线束 EPB-LB

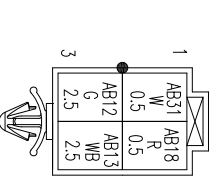

THB:PP0490701
接右前门玻璃升降开关 RD05

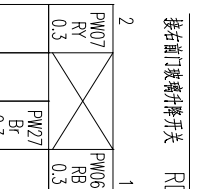

FCI:211PC022S8049
接右前门玻璃升降电机 RD03

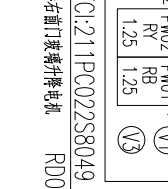

TE:1355390-1
接右前门线束 RD07

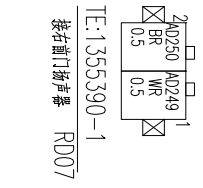

KOSTAL:09444024
接左前电子手刹 EPB-L

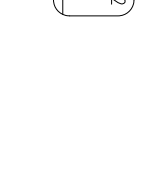

THB:PP0490701
接后门玻璃升降开关 LR02

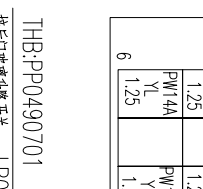

TE:1801175-3
接左后轮速传感器 ABS-LR

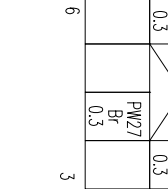

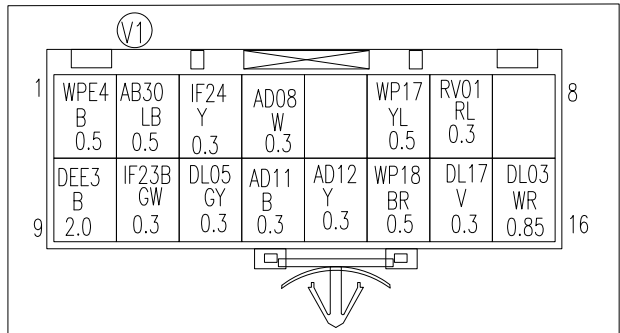

TE:936211-1
卡扣KET:MG631929
接左车身电线束总成 TT-LB1

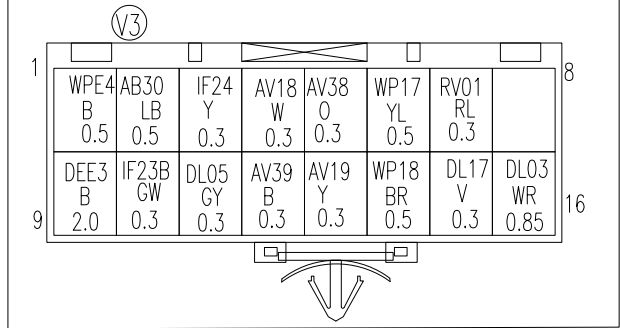

HL:CN2BSP(母端)
接牌照灯 BD02

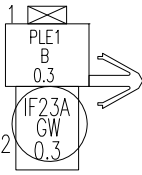

KET:MG610394
接后刮水电机 BD03

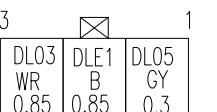

HL:TSS03FB
后背厢门锁电机及门锁开关 BD06

TE:936271-1
卡扣TE:368291-1
左后组合灯 LB07 (B灯)

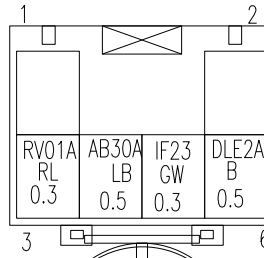

HL:3TK02MBRP
卡扣:MG630418
接微动开关 BD07

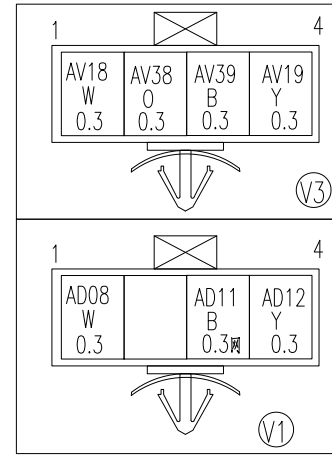
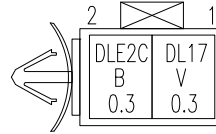

HL:3TK04MW
卡扣:MG630418
接后摄像头 BD08

DEE1 B 2.0
HL:3P01FB02BK
后除霜地 BD05

TE:936271-1
卡扣TE:368291-1 (B灯)
右后组合灯 LB07

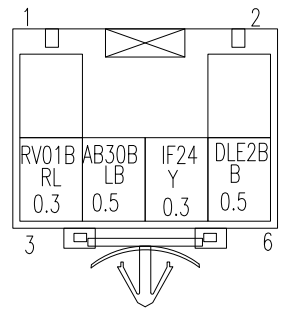

FLE3B B 0.3, FL11B B 0.3
左右雾灯 PB5

KUM:PB625-02027
KUM:PB875-02900

KET:MG640341
KET:MG630345-7
防水卡扣KET:MG664128(φ7-8)
接车架线束 PB-LB1

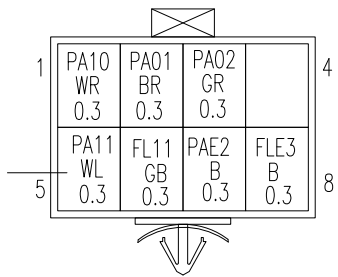

AMP 1-967642-1
倒车雷达传感器(中) PB3

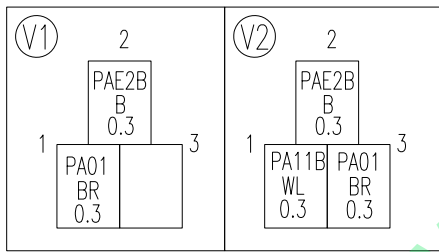

FLE3A B 0.3, FL11A GB 0.3
右后雾灯 PB5
KUM:PB625-02027
KUM:PB875-02900

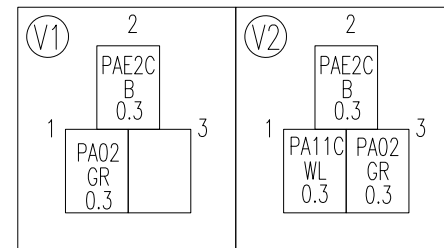

AMP 1-967642-1
倒车雷达传感器(左) PB2

FLE3B B 0.3, FL11B GB 0.3
左后雾灯 PB5
KUM:PB625-02027
KUM:PB875-02900

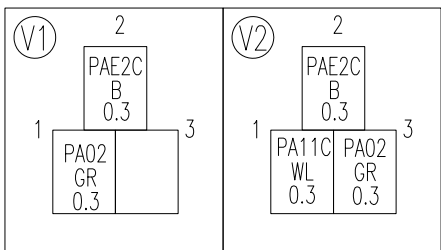

AMP 1-967642-1
倒车雷达传感器(左) PB2

AMP 1-967642-1
倒车雷达传感器(右) PB4

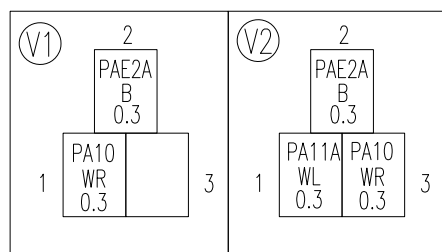

KET:MG640341
KET:MG630345-7
防水卡扣KET:MG664128(φ7-8)
接车架线束 PB-LB1

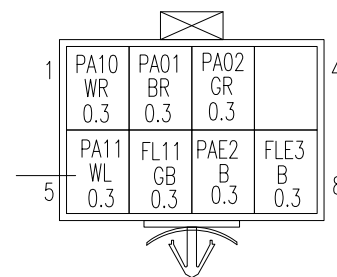

AMP 1-967642-1
倒车雷达传感器(中) PB3

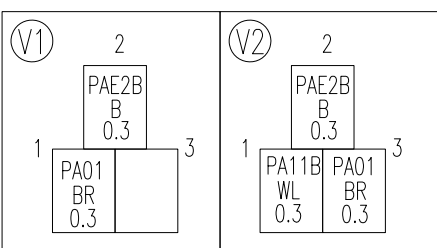

AMP 1-967642-1
倒车雷达传感器(右) PB4

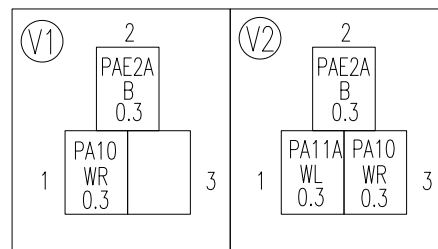

FLE3A B 0.3, FL11A GB 0.3
右后雾灯 PB5
KUM:PB625-02027
KUM:PB875-02900

TE:936092-1

接仪表板电缆束总成 FR-IP1

4	IF22 LW 0.3	IL02 RY 0.3	PLE2 B 0.3
		IL05 G 0.3	
10			

4	IF22 LW 0.3	IL02 RY 0.3	IF09 RW 1.25
		IL05 G 0.3	PW21 GB 0.3
			PLE2 B 1.25
10			

4	IP24 BL 0.5	IF22 LW 0.3	IL02 RY 0.3	IF09 RW 1.25
			IL05 G 0.3	PW21 GB 0.3
				PLE2 B 1.25
10	WP01 LR 0.3	IF18 LB 0.3	SFE1 B 0.3	IL02 RY 0.3

(V2) (V3)

AMP:1-1718346-1

接雨量传感器 FR01

3	WP01 LR 0.3	SFE1 B 0.3	IL02C RY 0.3
1			

TE: 1473672-1
TE: 1123343-1

接后室内灯及开关总成 FR04

1	IF22 LW 0.3	PLE2B B 0.3	IL02A RY 0.3	IL06 Y 0.3
4				

TE: 1473672-1
TE: 1123343-1

接右侧厢灯及开关总成 FR04

1	IF22 LW 0.3	PLE2B B 0.3	IL02A RY 0.3	IL06 Y 0.3
4				

(V1)

1	IL05A G 0.3	PLE2A B 0.3	IL02B RY 0.3
7	IL06 Y 0.3		

TE:1318774-1
端子TE:1123343-1
接前室内灯及开关总成 FR02

(V2)

1	PLE2D B 0.3	IL05A G 0.3	SF06 R 0.3	IL02B RY 0.3
7	IL06 Y 0.3	SF01 Lg 0.3	PLE2A B 0.3	

TE:1318774-1
端子TE:1123343-1
接前室内灯及开关总成 FR02

(V3)

1	PLE2D B 0.3	IL05A G 0.3	SF06 R 0.3	SF08 W 0.3	SF07 GR 0.3	IL02B RY 0.3
7	IL06 Y 0.3	SF01 Lg 0.3	PLE2A B 0.3			

TE:1318774-1
端子TE:1123343-1
接前室内灯及开关总成 FR02

(V2)

Yazaki:7283-5533-40

接天窗电机及控制器 FR03

5	SF06 R 0.3	IF18 LB 0.3	PW21 GB 0.3	IF09 RW 1.25	SF01 Lg 0.3
10	PLE2C B 1.25	IF18 LB 0.3	PW21 GB 0.3	IF09 RW 1.25	

(V3)

Yazaki:7283-6459-40

接全景天窗电机及控制器 FR03

5	IF09 RW 1.25	IP24 BL 0.5	SF01 Lg 0.3	SF06 R 0.3	PLE2C B 1.25
10		PW21 GB 0.3	SF08 W 0.3	SF07 GR 0.3	IF18 LB 0.3

TE: 1473672-1
TE: 1123343-1

接左右侧厢灯及开关总成 FR05

1	IF22 LW 0.3	PLE2B B 0.3	IL02A RY 0.3	IL06 Y 0.3
4				

AMP:282088-1(特殊)
接油泵及油量传感器 LB04

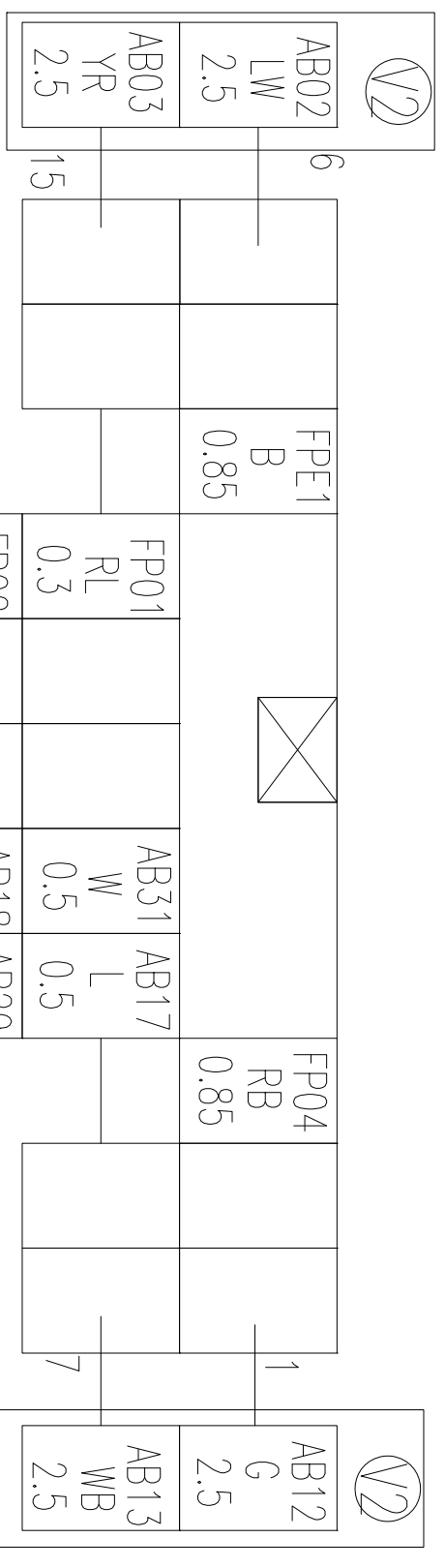
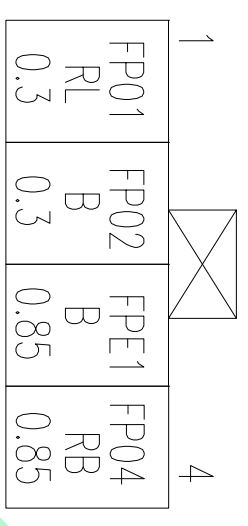

SWS:60985988
接左车身线束 LB33

AMP:1-967644-1
左后轮速传感器 LB03

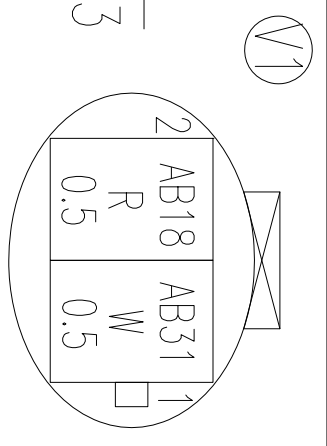

TE:936254-2
接左后EPB接线 LB-03

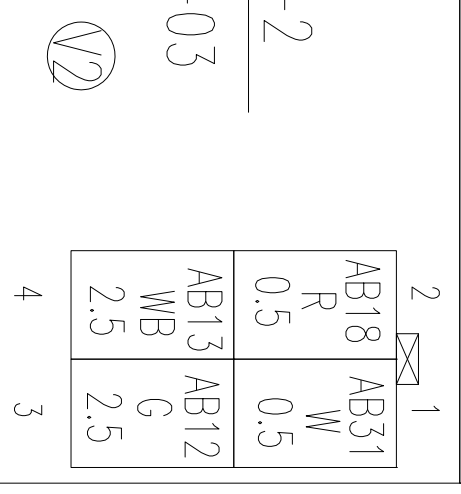

AMP:1-967644-1
右后轮速传感器 LB27

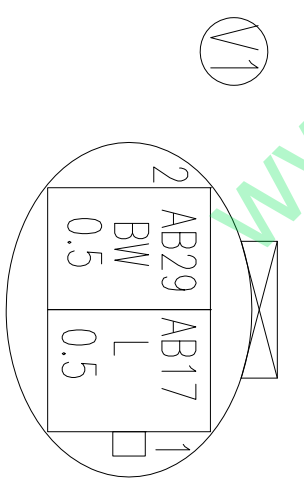

TE:936254-2
接右后EPB接线 LB-27

